

Surge arrester ETITEC group B EN/IEC/VDE: T1, T2, T3 / I, II, III / B+C+D

ETITEC B T12 Iimp=12,5kA			
Type	150/12,5	275/12,5	440/12,5
In accordance with	IEC/EN 61643-11		
Category IEC/EN/VDE	I, II, III / T1, T2, T3 / B, C, D		
Max. continuous operating voltage (AC) Uc	150 V	275 V	440 V
Nominal discharge current (8/20) In	25 kA		
Max. discharge current (8/20) I _{max}	60 kA		
Impulse current (10/350) I _{imp}	12,5 kA		
Nominal AC voltage U _o	230V 50-60 Hz		
TOV immunity U _T (AC)	334V/5s withstand 438 V/120 min safe disconnection		
Charge			
Protection level U _p - at I _n (8/20)	<1,0 kV	<1,4 kV	<2,0 kV
Follow current I _{fi}	x		
Response time t _a	< 25 ns		
Residual current I _{pe} at U _{ref}	< 0,3 mA		
Thermal decoupler	✓		
Torque	3,0 Nm		
Back-up fuse (if mains > 160A)	160 A gG		
Short-circuit current rating I _{scCR}	25 kA / 50 Hz		
Temperature range	- 40°C ... +70°C		
Cross-section of connection wire	min. 4mm ² , max. single strand 35mm ² , multi-strand 25mm ²		
Mounting	indoors on top hat fixing rail 35 mm (EN 60715)		
Degree of protection	IP 20		
Casing material	thermoplastic; extinguishing degree UL 94 V-0		
Dimensions	1 TE ... 4 TE		
Indication of disconnecter operation	red flag		
Permissible humidity	5% - 95%		
Additional data for ETITEC B-RC			
Remote signalisation (RC)	✓		
Switching capability (RC)	AC: 250V/0.5A; 125V/3A		
Cross-section of connection wire (RC)	max. 1.5 mm ²		
Torque (RC)	0,25 Nm		

Type of network and nr. of SPD poles

Network	Nr of poles (SPD configuration)
TNC 1 phase	1+0
TNC 3 phase	3+0
TNS 1 phase	2+0 / 1+1
TNS 3 phase	4+0 / 3+1
TT 1 phase	1+1
TT 3 phase	3+1
IT 1 phase	2+0
IT 3 phase	4+0

At TNC, TNS, TT systems with U_n=230V, recommended U_c value of SPD is 275V. IT rendszerben ajánlott U_c (varisztor) érték 440V.

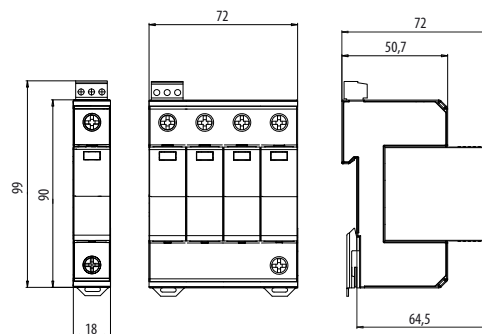

Technical data

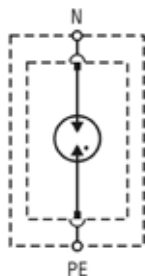

ETITEC BT12 G

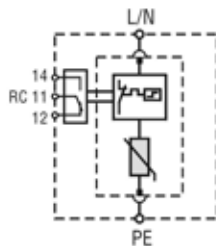

ETITEC BT12 1+0 RC

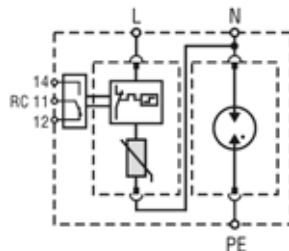

ETITEC BT12 1+1 RC

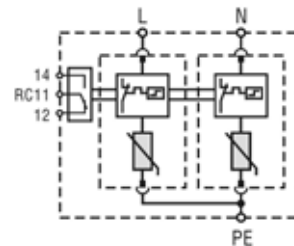

ETITEC BT12 2+0 RC

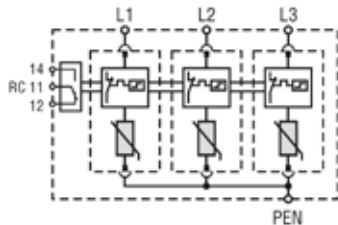

ETITEC BT12 3+0 RC

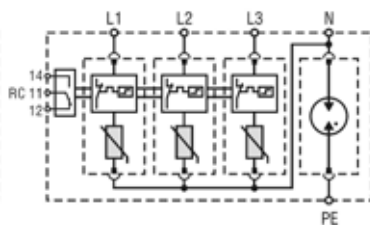

ETITEC BT12 3+1 RC

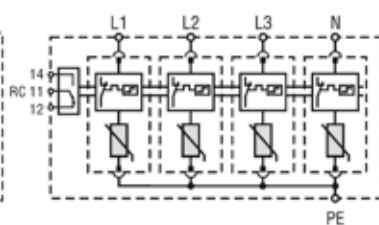

ETITEC BT12 4+0 RC